



CATALOGUE DE TARIFS ESPACE METAL

SARGENTON Jean-François
ESPACE METAL

LOCATION-VENTE

Fournitures pour le BTP

Siège social : Lot. Farraux

Route de la Jaille -97122 BAIE MAHAULT

Tél : 0590.26.79.11 – Fax : 0590.26.82.66

Table des matières

Table des matières

Table des matières	2
ACCESSOIRES DE COFFRAGE	4
1. GAMME MAGNETIQUE	4
2. CALES PLASTIQUE VERTICALE	5
3. CALES HORIZONTALES	5
4. ECARTEUR DE NAPPE	6
5. GAMME PANNEAU DE COFFRAGE TRICOLLE EP 27mm	6
6. AGENT DE DEMOULAGE/ PRODUIT DE CURE/ DECAPANT BETON	7
7. MATERIELS POUR LA DISTRIBUTION DU BETON	8
8. ESPACEURS DE COFFRAGE	9
9. COFFRAGE PERDUS	11
10. JOINT DE DILATATION	11
11. LITEAU ET GOUTTE D'EAU	12
12. DIVERS	12
VIBRATION ET COMPACTAGE	13
PETITS MATERIELS	16
1. GAMME MAGNETIQUE	16
2. REGLE ALUMINIUM	16
3. NETTOYAGE	17
4. REGLE A NIVEAUX	17
5. NIVEAUX	18
6. OUTILLAGES	18
7. CORDEAUX ET POUDRES	20
8. MESURES ET DISTANCES	21
9. ELECTRICITE	21
10. DIVERS	22
PROTECTION ET SECURITE DE CHANTIER	24
1. BARRIERES ET CLÔTURES DE CHANTIERS	24
1. ECHAFAUDAGE ALUMINIUM	25
2. PROTECTION INDIVIDUELLE ET SOINS	26
3. SECURITE COLLECTIVE	27
6. PETIT PANNEAUX DE CHANTIER	30
MATERIELS TOPOGRAPHIQUE	31
PLATEFORMES ET ECHAFAUDAGES	32
1. PLATEFORME INDIVIDUELLE ROULANTE	32
2. ECHAFAUDAGE GALVA	33
3. ECHELLE : conforme norme EN131	34

LOCATION-VENTE

Fournitures pour le BTP

Siège social : Lot. Farraux

Route de la Jaille -97122 BAIE MAHAULT

Tél : 0590.26.79.11 – Fax : 0590.26.82.66

4. GAMME GROS ŒUVRE.....	35
PANNEAUX DE SIGNALISATION CHANTIER.....	36
1. GAMME AK :	36
2. GAMME BK :	37
3. GAMME KD :	38
4. GAMME KC1 :	39
5. PANNEAUX DE SIGNALISATION POLICE/ROUTIERE :	40
PRE-FABRICATION ET LEVAGE.....	41
1. PREFABRICATION	41
2. LEVAGE.....	42



LOCATION-VENTE

Fournitures pour le BTP
Siège social : Lot. Farraux
Route de la Jaille -97122 BAIE MAHAULT
Tél : 0590.26.79.11 – Fax : 0590.26.82.66

ACCESSOIRES DE COFFRAGE

1. GAMME MAGNETIQUE

REFERENCE	DESIGNATION	PHOTO	
CO0065	BLOC AIMANT RESINE CEINT. MET. COEF GLISS 120KG		
CO0066	BLOC AIMANT RESINE JAUNE COEF GLISS 110KG		
CO0035	BLOC AIMANT RESINE ROUGE COEF GLISS 140KG		
CO0045	CONE AIMANTE MAX 18CM		
CO0046	CONE AIMANTE MAX 20CM		
CO0063	CONE AIMANTE 15CM		
CO0064	CONE AIMANTE 18CM		
CO0154	CONE AIMANTE 16CM		
CO0094	CONE AIMANTE 20CM		
CO0105	CONE AIMANTE MAX 25 cm		
CO0270	CONE AIMANTE 30CM		
CO0223	CONE DE COMPRESSION VOILE DE 15CM		
CO0146	CONE DE COMPRESSION VOILE DE 16CM		
CO0175	CONE DE COMPRESSION VOILE DE 18CM		
CO0197	CONE DE COMPRESSION VOILE DE 20CM		
CO0286	CONE DE COMPRESSION VOILE 25CM		
CO0294	CONE DE COMPRESSION VOILE 30CM		
CO0104	REGLE ARASE 1,25ML 40X32X30		
CO0001	TRIANGLE AIMANTE 20X10 L1.25		
CO0150	FIL A PLOMB MAGNETIQUE JAUNE 1200G		
CO0325	FIL A PLOMB MAGNETIQUE JAUNE 400G		
CO0148	FIL A PLOMB MAGNETIQUE BLEU 880 G		

Fournitures pour le BTP



Siège social : Lot. Farraux

Route de la Jaille - 97122 BAIE MAHAULT



Tél : 0590.26.79.11 – Fax : 0590.26.82.66

LOCATION-VENTE

2. CALES PLASTIQUE VERTICALE

REFERENCE	DESIGNATION	PHOTO
CO0027	CALE ENROBAGE 30mm (1000 unités)	
CO0028	CALE ENROBAGE 40mm (500 unités)	
CO0081	CALE ENROBAGE 50mm (250 unités)	
CO0174	SUPERFIX 40 (500 unités)	
CO0074	SUPERFIX 50 (200 unités)	
CO0089	ACROFIX 250/40 (200 unités)	

3. CALES HORIZONTALES

REFERENCE	DESIGNATION	PHOTO
CO0082	CALE BETON FIX 30 (240 unités)	
CO0100	CALE BETON FIX 40 (190 unités)	
CO0101	CALE BETON FIX 50 (130 unités)	
CO0029	POUTRELLE BOIS H20 EN 2,90M	
CO0024	POUTRELLE BOIS H20 EN 3,90M	
CO0236	POUTRELLE BOIS H20 EN 4,90M	
CO0062	UNICALE 30 2ML (50 unités)	
CO0128	UNICALE 40 2ML (40 unités)	
CO0003	UNICALE 50 2ML (40 unités)	

Fournitures pour le BTP

Siège social : Lot. Farraux

Route de la Jaille - 97122 BAIE MAHAULT

Tél : 0590.26.79.11 – Fax : 0590.26.82.66

LOCATION-VENTE

4. ECARTEUR DE NAPPE

REFERENCE	DESIGNATION (50 unités)	PHOTO
CO0079	POUTRELLE ZISTA RENFORCEE 50MM 2ML	
CO0050	POUTRELLE ZISTA RENFORCEE 70MM 2ML	
CO0051	POUTRELLE ZISTA RENFORCEE 90MM 2ML	
CO0052	POUTRELLE ZISTA RENFORCEE 110MM 2ML	

5. GAMME PANNEAU DE COFFRAGE TRICOLLE EP 27mm

6

REFERENCE	DESIGNATION	PHOTO
BAB033	CLAVETTE GRAND MODELE	
BAB039	CLAVETTE PETIT MODELE (50 unités)	
BAB032	ECARTEUR 15CM POUR PANNEAUX U27 (100 unités)	
BAB040	ECARTEUR 18CM POUR PANNEAUX U27 (100 unités)	
BAB041	ECARTEUR 20CM POUR PANNEAUX U27 (100 unités)	
BAB018	ECARTEUR 25CM POUR PANNEAUX U27 (100 unités)	
BAB047	ECARTEUR 30CM POUR PANNEAUX U27 (100 unités)	
CO0151	ETAI 0.75/1.10ML	
CO0008	ETAI 1.70/3.00ML	
CO0006	ETAI 2.20/4.00ML	
BAB035	PANNEAU TRICOLLE EP 27mm 2,50X0,50	
BAB028	PANNEAU TRICOLLE EP 27mm 3,00X0,50	

LOCATION-VENTE

Fournitures pour le BTP
 Siège social : Lot. Farraux
 Route de la Jaille -97122 BAIE MAHAULT
 Tél : 0590.26.79.11 – Fax : 0590.26.82.66

6. AGENT DE DEMOULAGE/ PRODUIT DE CURE/ DECAPANT BETON

REFERENCE	DESIGNATION	PHOTO
CO0306	COFRANET 5KG DECAPANT BETON	
CO0208	HUILE BIODÉM SI-3 1000L	
CO0007	HUILE BIODÉM SI-3 215L	
CO0005	HUILE BIODÉM SI-3 30L	
CO0095	MANDEHUILE 2000 1000L	
CO0097	MANDEHUILE 2000 215L	
CO0096	MANDEHUILE 2000 30L	
CO0280	PROTECSOL 215L	
CO0084	PROTECSOL 30L	



LOCATION-VENTE

Fournitures pour le BTP

Siège social : Lot. Farraux

Route de la Jaille -97122 BAIE MAHAULT

Tél : 0590.26.79.11 – Fax : 0590.26.82.66

7. MATERIELS POUR LA DISTRIBUTION DU BETON

REFERENCE	DESIGNATION	PHOTO
Etant donné la conjoncture actuelle, Les prix pour ces produits sont disponibles <u>uniquement</u> sur devis (Devis valable 7 jours).		
CO0132	BENNE A TUYAU D200 DROITE TI 1000L	
CO0301	BENNE A TUYAU D200 DROITE TI 2000L	
CO0131	BENNE A TUYAU D200 DROITE TI 500L	
CO0216	BENNE AUTO-VID 1000L	
CO0133	BENNE AUTO-VID 500L	
CO0183	COLLIER DE SERRAGE D200	
CO0155	CORDAGE NYLON D18 LG 5ML NOIR POUR BENNE A BETON	
CO0310	CORDAGE NYLON D18 LONG 4ML BLANC POUR BENNE BETON	
CO0207	SECAFUT (BAC DE RETENTION, SUPPORT FUT, BACHE)	
CO0138	TUYAU CAOUTCHOUC DIAM 200/ ML	



LOCATION-VENTE

Fournitures pour le BTP

Siège social : Lot. Farraux

Route de la Jaille -97122 BAIE MAHAULT

Tél : 0590.26.79.11 – Fax : 0590.26.82.66

8. ESPACEURS DE COFFRAGE

REFERENCE	DESIGNATION	PHOTO
CO0060	CAROTTE BETON VOILE 15CM (40 unités)	
CO0061	CAROTTE BETON VOILE 18CM (38 unités)	
CO0194	CAROTTE BETON VOILE 20CM (38 unités)	
CO0246	CAROTTE BETON VOILE 25CM (35 unités)	
CO0300	CAROTTE BETON VOILE 30CM (25 unités)	
CO0054	CHASSE CONE	
CO0014	CONE ETANCHEITE D22/26 (500 unités)	
CO0198	CONE ETANCHEITE D26/32 (500 unités)	
CO0220	CONE ETANCHEITE D32 (500 unités)	
BAB021	ECROUS D17 EMBASE 130	
CO0328	ECROUS D17 EMBASE 110	
CO0169	ECROUS D17 EMBASE 65	
CO0121	ECROUS D23 EMBASE 80	
CO0013	ENTRETOISE D22 2ML (25 unités)	
CO0069	ENTRETOISE D26 2ML (25 unités)	



LOCATION-VENTE

Fournitures pour le BTP

Siège social : Lot. Farraux

Route de la Jaille - 97122 BAIE MAHAULT

Tél : 0590.26.79.11 – Fax : 0590.26.82.66

CO0170	ESPACEUR MASSIF 15CM (50 unités)	
CO0020	ESPACEUR MASSIF 16CM (50 unités)	
CO0171	ESPACEUR MASSIF 18CM (50 unités)	
CO0172	ESPACEUR MASSIF 20CM (50 unités)	
CO0031	ESPACEUR MASSIF 25CM (25 unités)	
CO0123	ESPACEUR MASSIF 30CM (25 unités)	
CO0017	EXTRACTEUR DE CONE	
CO0071	TALONNETTE PLAST. D15CM (100 unités)	
CO0188	TALONNETTE PLAST. D16CM (100 unités)	
CO0072	TALONNETTE PLAST. D18CM (100 unités)	
CO0086	TALONNETTE PLAST. D20CM (100 unités)	
CO0075	TALONNETTE PLAST. D25CM (75 unités)	
CO0018	TIGE ZING D17 1ML	
CO0248	TIGE ZING D17 3ML	
CO0120	TIGE ZING D23 1ML	
CO0247	TIGE ZING D23 3ML	



LOCATION-VENTE

Fournitures pour le BTP

Siège social : Lot. Farraux

Route de la Jaille - 97122 BAIE MAHAULT

Tél : 0590.26.79.11 – Fax : 0590.26.82.66

9. COFFRAGE PERDUS

REFERENCE	DESIGNATION	PHOTO
CO0033	COFFRAGE LISSE D200 3M	
CO0037	COFFRAGE LISSE D250 3M	
CO0034	COFFRAGE LISSE D300 3M	
CO0058	COFFRAGE LISSE D350 3M	
CO0039	COFFRAGE LISSE D400 3M	
CO0042	COFFRAGE LISSE 20x20 3M CHANFREINE	
CO0273	COFFRAGE LISSE 25x25 3M CHANFREINE	
CO0108	COFRAPLAQUE 60mm 2,80X1,20 (FEUILLE DE 3,36m ²)	
CO0098	NERGALVEX 1,5 M ² (20 FEUILLES)	
CO0099	PANNEAUX COFFRAGE FONDATION EP 8mm 1,20X2,40	



10. JOINT DE DILATATION

REFERENCE	DESIGNATION	PHOTO
CO0056	COUVRE JOINT D'ANGLE 120 3ML AVEC 3 CLIPS XL	
CO0073	COUVRE JOINT PLAT 120 3ML AVEC 3 CLIPS XL	

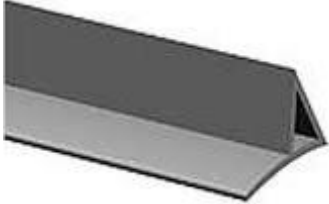

LOCATION-VENTE

Fournitures pour le BTP
 Siège social : Lot. Farraux
 Route de la Jaille –97122 BAIE MAHAULT
 Tél : 0590.26.79.11 – Fax : 0590.26.82.66

11. LITEAU ET GOUTTE D'EAU

REFERENCE	DESIGNATION	
CO0206	LITEAU A BAVETTE RENFORCE 15X15X20 2.50ML (100ML)	
CO0210	LITEAU A BAVETTE RENFORCE 20X20X28 2.50ML (100ML)	
CO0057	GOUTTE D'EAU A 12 2ML GRIS	
CO0238	LITEAU TRIANGULAIRE 15X15X20 2.50ML (100ML)	
CO0119	LITEAU TRIANGULAIRE 20X20X28 2.50 ML (100 ML)	

12. DIVERS





REFERENCE	DESIGNATION	
CO0090	BOITE ATTENTE 6/100 LG: 1.2ML	
CO0320	BOITE ATTENTE 8/100 LG: 1.2ML	
CO0115	FILM POLYANE 6 ML 150 MICRONS	



LOCATION-VENTE

Fournitures pour le BTP
 Siège social : Lot. Farraux
 Route de la Jaille –97122 BAIE MAHAULT
 Tél : 0590.26.79.11 – Fax : 0590.26.82.66

VIBRATION ET COMPACTAGE

REFERENCE	DESIGNATION	
PB0001	MOTEUR AVMU	
PB0035	TAX 3M	
PB0037	TAX 5M	
PB0045	AIGUILLE AX 25	
PB0004	AIGUILLE AX 40	
PB0003	AIGUILLE AX 48	
PB0048	MOTEUR DINGO	
PB0068	TDX 3M	
PB0050	TDX 5M	







LOCATION-VENTE

Fournitures pour le BTP

Siège social : Lot. Farraux

Route de la Jaille - 97122 BAIE MAHAULT

Tél : 0590.26.79.11 – Fax : 0590.26.82.66

PB0055	VIBREUR PORTATIF BACKPACK	
PB0020	CONVERTISSEUR AFE 1000M COMPACT	
PB0012	CONVERTISSEUR AFE 2000M	
PB0086	CONVERTISSEUR AFE 4500	
PB0023	AIGUILLE HAUTE FREQUENCE M38 AFP LG 5ML	
PB0089	AIGUILLE HAUTE FREQUENCE M38 AFP LG 7ML	
PB0024	AIGUILLE HAUTE FREQUENCE M50 AFP LG 5ML	
PB0063	AIGUILLE HAUTE FREQUENCE M50 AFP LG 7ML	
PB0075	AIGUILLE HAUTE FREQUENCE M60 AFP LG 5ML	
PB0085	AIGUILLE HAUTE FREQUENCE M60 AFP LG 7ML	
PB0019	MOTEUR POUR REGLE TORNADO	
PB0040	PROFIL 1.5M POUR REGLE TORNADO	
PB0051	PROFIL 2.5M POUR REGLE TORNADO	
PB0042	PROFIL 2M POUR REGLE TORNADO	
PB0052	PROFIL 3M POUR REGLE TORNADO	
PB0080	PROFIL 4 ML POUR REGLE TORNADO	







LOCATION-VENTE

Fournitures pour le BTP

Siège social : Lot. Farraux

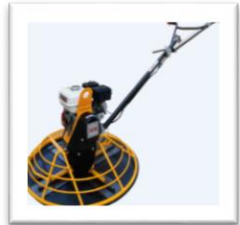
Route de la Jaille - 97122 BAIE MAHAULT

Tél : 0590.26.79.11 – Fax : 0590.26.82.66







PB0080	TRUELLE MECANIQUE TIFON 601	 
PB0030	TRUELLE MECANIQUE TIFON 900 MANCHE PLIANT	
PB0013	TRUELLE MECANIQUE TIFON 1200	
PB0082	JEU DE PALE FINITION 600 POUR TRUELLE MECA	
PB0033	JEU DE PALE FINITION 900 POUR TRUELLE MECA	
PB0036	JEU DE PALE FINITION 1200 POUR TRUELLE MECA	
PB0002	JEU DE PALE MIXTE 900 POUR TRUELLE MECA	
PB0049	JEU DE PALE MIXTE 1200 POUR TRUELLE MECA	
PB0043	PILONNEUSE PH 70E	
PB0011	PLAQUE VIBRANTE 12/36 avec roue	
PB0017	PLAQUE VIBRANTE PCLX 320 avec roue	
PB0016	PLAQUE VIBRANTE PCX500 avec roue	

LOCATION-VENTE







Fournitures pour le BTP
 Siège social : Lot. Farraux
 Route de la Jaille -97122 BAIE MAHAULT
 Tél : 0590.26.79.11 – Fax : 0590.26.82.66

PETITS MATERIELS

1. GAMME MAGNETIQUE

REFERENCE	DESIGNATION	
FS0030	TUYAU PVC PROFESSIONNEL 5 COUCHES 25ML (DIAM.19)	
FS0031	TUYAU PVC PROFESSIONNEL 5 COUCHES 50ML (DIAM.19)	
FS0041	NEZ DE ROBINET FILETE DE 3/4 DIAM.19MM	
FS0097	RACCORD DOUBLE MALE DIAM.19MM	
FS0038	LANCE REGLABLE BI-MATIERE DIAM.19MM	
FS0035	RACCORD RAPIDE AUTO DIAM.19MM	

2. REGLE ALUMINIUM

REFERENCE	DESIGNATION	
FS0281	REGLE ALU 2,5ML	
FS0191	REGLE ALU 2ML	
FS0248	REGLE ALU 3ML	
FS0321	REGLE ALU 4ML	
FS0322	REGLE ALU 5ML	
FS0513	REGLE ALU 6ML	

Fournitures pour le BTP











Siège social : Lot. Farraux

Route de la Jaille - 97122 BAIE MAHAULT





Tél : 0590.26.79.11 – Fax : 0590.26.82.66

LOCATION-VENTE

3. NETTOYAGE

REFERENCE	DESIGNATION	
FS0251	BALAI DE PISTE BALDOZER 55CM	
FS0061	BALAI DE CANTONNIER BALDOZER 32CM	
FS0303	BALAI COCO A VIS 29CM 5 RANGS	
FS0211	BALAI DE CANTONNIER PIASSAVA 32CM	
FS0310	RACLETTE METALLIQUE RENFORCEE DOUBLE MOUSSE 75CM + MANCHE FS0163	
FS0027	MANCHE BOIS POUR BALAIS BALDOZER ET PIASSAVA Diam.28mm L140CM	
FS0304	MANCHE BOIS POUR BALAIS COCO Diam.24mm L130CM A VIS	
FS0076	COUVERCLE PLASTIQUE DE POUBELLE DE CHANTIER 75L	
FS0070	POUBELLE DE CHANTIER 75L PLASTIQUE	
FS0077	SACS POUBELLE 75/100 L POUR POUBELLE DE CHANTIER	

4. REGLE A NIVEAUX

REFERENCE	DESIGNATION	
FS0118	REGLE A NIVEAU 1,50 M	
FS0247	REGLE A NIVEAU 2,50 M	
FS0127	REGLE A NIVEAU 2,00 M	
FS0112	REGLE A NIVEAU 3,00 M	



LOCATION-VENTE

Fournitures pour le BTP
 Siège social : Lot. Farraux
 Route de la Jaille -97122 BAIE MAHAULT
 Tél : 0590.26.79.11 – Fax : 0590.26.82.66

5. NIVEAUX

REFERENCE	DESIGNATION	
FS0198	NIVEAU TALIACHOC TRAPEZE 60CM	
FS0261	NIVEAU TALIACHOC TRAPEZE 80CM	
FS0182	NIVEAU NIVOTOP ALUMINIUM PROFIL I 1,50 M	
FS0181	NIVEAU NIVOTOP ALUMINIUM PROFIL I 1,00 M	
FS0180	NIVEAU NIVOTOP ALUMINIUM PROFIL I 2,00 M	

6. OUTILLAGES

REFERENCE	DESIGNATION	
FS0348	CISAILLE A TOLE PROFESSIONNELLE	
CO0110	BROUETTE 90L ROUE INCREVABLE	
FS0293	COUPE BOULON 600	
FS0233	COUPE BOULON 750	
FS0160	COUPE BOULON 900	
CO0122	APPAREIL A LIGATURER 320MM	
FS0078	GRATTOIR DE COFFRAGE RENFORCE 30CM	
FS0079	MANCHE DE GRATTOIR DE COFFRAGE BOIS	
FS0132	PLATOIR CHAPISTE INOX 60X10CM DOUBLE ARRONDI	
FS0116	PLATOIR CHAPISTE INOX 120X11CM DOUBLE ARRONDI	
FS0115	MANCHE TELESCOPIQUE AVEC ARTICULATION ORIENTABLE POUR PLATOIR	





















Fournitures pour le BTP

Siège social : Lot. Farraux

Route de la Jaille -97122 BAIE MAHAULT

Tél : 0590.26.79.11 – Fax : 0590.26.82.66

LOCATION-VENTE

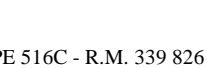
FS0315	PLATOIR FLAMAND INOX 55CM	
FS0519	BALAI CHAPISTE PVC 55CM	
FS0354	MANCHE TELESCOPIQUE 4.5M POUR BALAI CHAPISTE	
FS0169	TENAILLE RUSSE 28CM	
FS0152	TENAILLE RUSSE 25CM	
FS0187	PINCE A DECOFFRER 80CM	
FS0511	BARRE A MINE A TALON L150	
FS0137	BARRE A MINE L175	
FS0183	BARRE A MINE A PALETTE	
FS0134	PELLE RONDE 29CM	
FS0167	MANCHE DE PELLE BOIS 130CM	
FS0135	PIOCHE 2,5KG + MANCHE FS0251	
FS0251	MANCHE DE PIOCHE BOIS	
FS0243	RATEAU STANDARD 14 DENTS SANS MANCHE	
FS0359	RATEAU A GOUDRON SANS MANCHE	
FS0152	RATEAU RACLOIR A BETON SANS MANCHE	
FS0148	EPANDEUR A BETON ACIER 50CM	
FS0363	EPANDEUR A BITUME ALUMINIUM TP AVEC MANCHE 150CM	
FS0244	MANCHE BOIS RATEAUX 150CM	
FS0151	MARTEAU COFFREUR MANCHE FIBRE	
FS0179	MASSE COUPLE 4KG MANCHE FIBRE	





Fournitures pour le BTP

Siège social : Lot. Farraux







Route de la Jaille - 97122 BAIE MAHAULT

Tél : 0590.26.79.11 – Fax : 0590.26.82.66

LOCATION-VENTE

FS0159	MASSETTE 1,2KG MANCHE FIBRE	
FS0141	SCIE DE COFFREUR 600 MM POIGNEE BI-MATIERE	
FS0020	SCIE METAUX	
CO0354	TABLE DE DECOUPE REPLIABLE GALVA FINITION MARTHYRS AVEC ROUES	
CO0111	CLE DE BANCHE A CLIQUET DIAM 36	
CO0019	CLE DE BANCHE A CLIQUET DIAM 38	

7. CORDEAUX ET POUDRES

REFERENCE	DESIGNATION	
FS0158	CORDEAU CORDEX ROUGE 30M FIL 1MM TRESSE	
FS0107	CORDEAU GEANT A TRACER ROUGE	
FS0114	CORDEAU MAGNUM A TRACER ROUGE	
FS0128	CORDEAU POLYPRO TRESSE ROSE FLUO 200M FIL 2,5MM	
FS0039	CORDEAU POLYPRO TRESSE BLANC 200M FIL 2MM	
FS0284	POUDRE A TRACER POUR CORDEAU 1KG (Blanche, Bleue, Rouge)	

Fournitures pour le BTP









Siège social : Lot. Farraux

Route de la Jaille –97122 BAIE MAHAULT





Tél : 0590.26.79.11 – Fax : 0590.26.82.66

LOCATION-VENTE

8. MESURES ET DISTANCES

REFERENCE	DESIGNATION	
FS0054	QUINTUPLE DECAMETRE RUBAN ACIER	
FS0196	TRIPLE DECAMETRE RUBAN ACIER	
MT0074	QUINTUPLE DECAMETRE PRO RUBAN FIBRE BOITIER BI-MATIERE	
MT0101	MESURE CHAR-FLEX 10M X 25MM BLISTER	
MT0307	MESURE CHAR-FLEX 3M X 19MM BLISTER	
MT0308	MESURE CHAR-FLEX 5M X 25MM BLISTER	
MT0309	MESURE CHAR-FLEX 8M X 25MM BLISTER	
MT0290	ODOMETRE NEDO + SAC	
MT0265	ODOMETRE SPECIAL TP (+SAC DE TRANSPORT)	

9. ELECTRICITE

REFERENCE	DESIGNATION	
FS0341	COFFRET DE CHANTIER 4 PRISES	
FS0302	COFFRET DE CHANTIER 8 PRISES	
FS0278	ENROULEUR ELECTRIQUE 25ML	
FS0279	ENROULEUR ELECTRIQUE 40ML	

LOCATION-VENTE

Fournitures pour le BTP
 Siège social : Lot. Farraux
 Route de la Jaille –97122 BAIE MAHAULT
 Tél : 0590.26.79.11 – Fax : 0590.26.82.66

10. DIVERS

REFERENCE	DESIGNATION	
CO0161	ADHESIF PVC ORANGE 50MM	
FS0300	AUGE 30L	
CO0297	BIG BAG 1T (80X80X90)	
FS0289	BOBINE PAPIER 24 X 24 ESSUIE-MAINS	
FS0147	CRAIE BLEUE/ JAUNE/ ROUGE/ BLANCHE	
FS0012	CRAYON TAILLEUR DE PIERRE VERT 30CM	
FS0239	CRAYON DE CHARPENTIER ROUGE 25CM	
MT0315	CUTTER PRO BI-MATIERE LAME 25 MM SK2 (BLISTER)	
FS0527	TUBES DE 10 LAMES 25MM AUTO-CASSANTES SK2	
FS0356	DISQUE ABRASIF POUR METAUX 125MM	
FS0094	DISQUE ABRASIF POUR METAUX 230MM	
FS0017	FICELLE A AIGUILLER (Résistance : 55 kg) 1200M	
CO0256	FIL RECUIT D1.3MM ROULEAU DE 5KG	
FS0255	GRAISSE 18KG	
CO0224	HOUSSE DE PLAN 150X100	
FS0095	JERRICAN PLASTIQUE 20 LITRES (HOMOLOGUE HYDROCARBURE)	
-	MARQUEUR PERMANENT BLEU, ROUGE, NOIR	



LOCATION-VENTE

Fournitures pour le BTP

Siège social : Lot. Farraux

Route de la Jaille - 97122 BAIE MAHAULT

Tél : 0590.26.79.11 – Fax : 0590.26.82.66

FS0154	PORTE MARTEAU EN CUIR	
CO0116	PULVERISATEUR ACIER 6L	
FS0171	PULVERISATEUR CUVE PLASTIQUE 5L	
CO0335	PULVERISATEUR A DOS 17L	
CO0326	LANCE PULVERISATEUR ACIER GOLZPER	
FS0298	ROULEAUX PVC ADHESIF MULTICOLOR	
FS0140	SANGLE D'ARRIMAGE A CLIQUET 5MX25MM BLEUE	
FS0172	SANGLE D'ARRIMAGE A CLIQUET 6MX35MM ORANGE	
FS0185	SANGLE D'ARRIMAGE A CLIQUET 9MX50MM BLEUE	
CO0076	SEAU DE 20 KG BOBINE DE FIL A LIGATURER D1.40mm	
FS0125	SEAU PRO BLEU 13 LITRES A POIGNEE ET ERGOTS Anse 5,3mm	
CO0118	SERRE JOINT ACIER 80X100	
FS0201	TALIATUBE 115X115X100CM	
FS0350	TALOCHE ABS 42x28CM RECTANGLE JAUNE	
FS0193	TAMIS PLASTIQUE PRO TAMIPLAST N°8	
FS0194	TAMIS PLASTIQUE PRO TAMIPLAST N°12	
MT0093	TUBE MARQUEUR : jaune, rouge, bleu	

LOCATION-VENTE

Fournitures pour le BTP







Siège social : Lot. Farraux

Route de la Jaille -97122 BAIE MAHAULT

Tél : 0590.26.79.11 – Fax : 0590.26.82.66

PROTECTION ET SECURITE DE CHANTIER

1. BARRIERES ET CLÔTURES DE CHANTIERS

REFERENCE	DESIGNATION	
FS0028	BARRIERE DE CHANTIER PLASTIQUE ORANGE	
CO0124	BARRIERE CLOTURE MOBILE 350X190 ML 4 BARRES	
PS0043	BARRIERE TP ROUGE ET BLANCHE A PLAQUE	
CO0126	COLLIER ANTI-VANDALISME	
CO0253	JAMBE DE FORCE POUR CLOTURE CHANTIER	
CO0307	PLAQUE DE SECURITE GALVA POUR BAIE/FENETRE	
CO0125	PLOT BETON 32KG	
CO0272	PLOT PLASTIQUE 16KG	



LOCATION-VENTE

Fournitures pour le BTP
 Siège social : Lot. Farraux
 Route de la Jaille -97122 BAIE MAHAULT
 Tél : 0590.26.79.11 – Fax : 0590.26.82.66

1. ECHAFAUDAGE ALUMINIUM

REFERENCE	DESIGNATION	
ECH001	SERENITE 205 ½ BASE	
ECH003	SERENITE 205 KIT PLANCHER	
ECH005	SERENITE 205 REHAUSSE 1M	
ECH008	SERENITE 205 REHAUSSE 3M	
ECH009	SERENITE 255 ½ BASE	
ECH010	SERENITE 255 KIT PLANCHER	
ECH011	SERENITE 255 REHAUSSE 1M	
ECH014	SERENITE 255 REHAUSSE 3M	

Fournitures pour le BTP

Siège social : Lot. Farraux

Route de la Jaille -97122 BAIE MAHAULT

Tél : 0590.26.79.11 – Fax : 0590.26.82.66

LOCATION-VENTE

2. PROTECTION INDIVIDUELLE ET SOINS

REFERENCE	DESIGNATION	
-	BOTTES PVC SECURITE (Taille 40 à 48)	
-	CASQUE OPUS : blanc, vert, jaune, bleu, rouge	
FS0092	COQUILLE ANTI BRUIT POUR CASQUE CHANTIER	
-	CHAUSSURE DE SECURITE (Taille 40 à 48)	
-	CHAUSSURE DE SECURITE haut de gamme (Taille 40 à 46)	
FS0240	GANT ANTI COUPURE	
FS0050	GANT CUIR	
FS0044	GANT ENDUCTION NITRILE	
FS0343	GANT POLYAMIDE ENDUCTION	
FS0082	GILET DE SIGNALISATION JAUNE CL2 RETROREFLECHISSANT	
FS0123	GILET DE SIGNALISATION XL ORANGE	
FS0234	LUNETTE VISILUX INCOLORE	
FS0292	LUNETTE FUMEE ANTI UV TEINTEE	
FS0150	PORTE BADGE ADHESIF	
FS0045	TROUSSE DE SECOURS SPECIAL BTP GRAND MODELE	
FS0007	TROUSSE DE SECOURS SPECIAL BTP PETIT MODELE	



LOCATION-VENTE

Fournitures pour le BTP
 Siège social : Lot. Farraux
 Route de la Jaille -97122 BAIE MAHAULT
 Tél : 0590.26.79.11 – Fax : 0590.26.82.66

3. SECURITE COLLECTIVE

REFERENCE	DESIGNATION	
CO0059	CONSOLE DE FACADE AVEC POTELET 1ML	
CO0278	FILET ANTI-CHUTE 5X10 RALING	
CO0213	FILET ANTI-CHUTE 20X10 RALING	
CO0085	FILET BLANC FACADIER 3X20m 55G/M2	
CO0102	FILET PERIPHERIQUE 1X10ML	
CO0142	FILET PERIPHERIQUE 1X20ML	
CO0068 OU CO0338	PIED GARDE CORPS PLAST D42 NOIR (150 unités) OU PIED GARDE CORPS PLAST D42 ORANGE (50 unités)	
CO0049 OU CO0337	PIED GARDE CORPS PLAST D26 MARRON (100 unités) OU PIED GARDE CORPS PLAST D26 JAUNE (100 unités)	
CO0275	PINCE DALLE MULTIDIRECTIONNEL D40	







LOCATION-VENTE

Fournitures pour le BTP

Siège social : Lot. Farraux

Route de la Jaille -97122 BAIE MAHAULT

Tél : 0590.26.79.11 – Fax : 0590.26.82.66

CO0015	PINCE DALLE REVERSIBLE + POTELET D40	
CO0016	PINCE DALLE UNIMAG A BLOQUEUR	
CO0212	POTELET DIAM 25 A BLOQUEUR	
CO0130	POTELET DIAM 40 A BLOQUEUR	
CO0277	POTELET MULTIDIRECTIONNEL D25	
CO0274	POTELET MULTIDIRECTIONNEL D40	
CO0289	SUPPORT DEPORTE POTELET D25	
PS0286	TUBE LG 3ML GALBA+BOUCHON	

Fournitures pour le BTP

Siège social : Lot. Farraux

Route de la Jaille -97122 BAIE MAHAULT

Tél : 0590.26.79.11 – Fax : 0590.26.82.66

LOCATION-VENTE

4. EVACUATION

REFERENCE	DESIGNATION	
CO0093	CADRE DE DEPART GOULOTTE	
CO0092	GOULOTTE COMPLETE PRO JAUNE P51001Y	
CO0091	GOULOTTE DEPART PRO JAUNE P51010Y	

5. SIGNALISATION DE CHANTIER ET COMMUNICATIONS

REFERENCE	DESIGNATION	
FS0036	CONE PLASTIQUE CL1 75CM	
FS0102	CONE PLASTIQUE CL2 75CM RETROREFLECHISSANT	
CO0205	GOUTTIERE DE SECURITE 1ML	
FS0032	RUBAFORT 200X75	
FS0001	RUBAFORT 50X100	
CO0048	SIGNAL ACIER 6/20 (250 unités)	
CO0067	SIGNAL ACIER 16/32 (200 unités)	
MT0048	TALKY WALKIE MOTOROLA X T420	
MT0291	TALKY WALKY PACK MOTOROLA XT 180 (LA PAIRE)	
-	TRACEUR CHANTIER : rouge, marron, jaune, bleu, blanc, violet, vert, orange, noir	



LOCATION-VENTE

Fournitures pour le BTP

Siège social : Lot. Farraux

Route de la Jaille - 97122 BAIE MAHAULT

Tél : 0590.26.79.11 – Fax : 0590.26.82.66

6. PETIT PANNEAUX DE CHANTIER

REFERENCE	DESIGNATION	
NO0076	PANNEAU DE CHANTIER 4 EN 1 800 X400	
NO0022	PANNEAU DE CHANTIER 10 EN 1 800X400	
FS0062	PANNEAU 4 EN1 SPECIAL COVID	
NO0069	CHANTIER INT. AU PUBLIC DIAM. 42*	
NO0019	CHANTIER INTERDIT AU PUBLIC 330 x 200*	
TS0001	KIT TRIFLASH RAPID CONNECT 130/30	
TS0003	KIT BIFLASH RAPID CONNECT 210/80	
TS0066	PILE 6 VOLTS RESSORTS	







*Vous trouverez dans la gamme :

- Port du casque
- Stationnement interdit
- Parking
- Piéton passez en face
- Interdit aux piétons
- Sens obligatoire
- Sens interdit
- Stop
- Défense de passer sous la charge

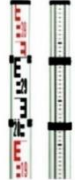
LOCATION-VENTE

Fournitures pour le BTP
Siège social : Lot. Farraux
Route de la Jaille - 97122 BAIE MAHAULT
Tél : 0590.26.79.11 – Fax : 0590.26.82.66

MATERIELS TOPOGRAPHIQUE



REFERENCE	DESIGNATION	
MT0084	CELLULE ROD EYE 140 CLASSIC	
MT0047	MIRE ALU 4ML	
MT0013	MIRE ALU 5ML	
MT0003	NIVEAU LEICA NA 720 + TREPIED ALU LOURD + MIRE 4M	
MT0008	NIVEAU LASER RUGBY 610 +TREPIED ALU LOURD +MIRE 4M	
MT0199	THEODOLITE NEDO ET 5L	
MT0017	TREPIED ALU CTP 104 AVEC BRETELLE	
MT0179	TREPIED LOUR A CREMAILLERE MAX 2.46	

LOCATION-VENTE

Fournitures pour le BTP
 Siège social : Lot. Farraux
 Route de la Jaille –97122 BAIE MAHAULT
 Tél : 0590.26.79.11 – Fax : 0590.26.82.66

PLATEFORMES ET ECHAFAUDAGES

1. PLATEFORME INDIVIDUELLE ROULANTE

REFERENCE	DESIGNATION	
ECH021	TANDEM PRO F6 (HAUT TRAVAIL : 3.45ML)	
ECH017	TANDEM PRO F7 (HAUT TRAVAIL : 3.70ML)	
ECH023	TANDEM PRO XT5 (HAUT. TRAV. : 2.81-3.31 ML)	
ECH032	TANDEM PRO XT7 (HAUT. TRAV. : 3.06-3.82 ML)	
ECH015	TANDEM PRO XT9 (HAUT. TRAV. : 3.57-4.33 ML)	
ECH016	TANDEM T-REX 2 MARCHES (HAUT TRAVAIL : 2.50ML)	
ECH018	TANDEM T-REX 3 MARCHES (HAUT TRAVAIL : 2.70ML)	
ECH019	TANDEM T-REX 4 MARCHES (HAUT TRAVAIL : 2.95 ML)	
ECH020	TANDEM T-REX 5 MARCHES (HAUT TRAVAIL : 3.20ML)	



LOCATION-VENTE

Fournitures pour le BTP
 Siège social : Lot. Farraux
 Route de la Jaille –97122 BAIE MAHAULT
 Tél : 0590.26.79.11 – Fax : 0590.26.82.66

2. ECHAFAUDAGE GALVA

REFERENCE	DESIGNATION		
EAL001	RSECUR 300 HAUT PLANCHER 2ML		
EAL002	RSECUR 300 REHAUSSE		
EAL005	RSECUR 200 HAUT PLANCHER 2ML		
EAL006	RSECUR 200 REHAUSSE		
EAL036	RSECUR STABILISATEUR 6-8ML		
EAL037	RSECUR STABILISATEUR SUPPLEMENTAIRE 8-12ML		
EAL038	RSECUR STABILISATEUR SUPPLEMENTAIRE 10-14ML		
EAL003	RSECUR KIT GRUTABLE		
EAL032	EVOLIS 160 VERSION DE BASE 1.70ML		
EAL033	EVOLIS 160 REHAUSSE 1.50ML		
EAL034	EVOLIS 160 PLANCHER SUPPLEMENTAIRE		
EAL035	EVOLIS 160 COMPLEMENT STABILISATEUR		

LOCATION-VENTE





Fournitures pour le BTP

Siège social : Lot. Farraux

Route de la Jaille - 97122 BAIE MAHAULT

Tél : 0590.26.79.11 – Fax : 0590.26.82.66

3. ECHELLE : conforme norme EN131

REFERENCE	DESIGNATION	
EM0004	ECHELLE ALU SIMPLE 3M	
EM0005	ECHELLE ALU SIMPLE 4M	
EM0029	ECHELLE ALU SIMPLE 5M	
EM0002	ECHELLE COULISSANTE ALU 2 PLANS AVEC STABILISATEUR 4.55/7.65ML	
EM0046	ECHELLE COULISSANTE ALU 2 PLANS AVEC STABILISATEUR 5.25/9.15ML	
EM0016	ECHELLE COULISSANTE ALU 3 PLANS AVEC STABILISATEUR 4.95/12.20ML	
EM0001	ECHELLE TRANSFORMABLE 2 PLANS 2.85/4.55ML	
EM0012	ECHELLE TRANSFORMABLE 3 PLANS 2.85/6.50ML	
EM0043	ECHELLE TRANSFORMABLE 3 PLANS 3.40/7.90ML	
EM0008	ECHELLE TELESCOPIQUE COMPACT BLUE 2.65ML	
EM0031	ECHELLE TELESCOPIQUE BAMBOO HAUTEUR 3.43ML	
EM0025	ECHELLE TELESCOPIQUE BAMBOO HAUTEUR 4ML	

Fournitures pour le BTP





Siège social : Lot. Farraux

Route de la Jaille - 97122 BAIE MAHAULT

Tél : 0590.26.79.11 – Fax : 0590.26.82.66

LOCATION-VENTE

4. GAMME GROS ŒUVRE

REFERENCE	DESIGNATION	
ECH051	ACCES DALLE HT ACCES 2.00-3.00M	
ECH039	ACCES DALLE HAUT ACCES 2.8-4.45ML	
ECH038	ACCES PREMUR INDIVIDUEL	
ECH050	ACCES FOND FOSSE PROFONDEUR 1.10 à 2.30 ML	
ECH061	ACCES FOND FOUILLE 0,80 à 1,80ML	
CO0334	ESCALIER DE CHANTIER EMAP ECO COMPLET 18 MARCHES	





LOCATION-VENTE

Fournitures pour le BTP
Siège social : Lot. Farraux
Route de la Jaille –97122 BAIE MAHAULT

Tél : 0590.26.79.11 – Fax : 0590.26.82.66

PANNEAUX DE SIGNALISATION CHANTIER

1. GAMME AK :

REFERENCE	DESIGNATION	
PS0004	AK14 1000 CL1 Danger	
PS0233	AK14 1000 CL2 Danger	
PS0002	AK17 1000 CL1 Feux	
PS0232	AK17 1000 CL2 Feux	
PS0001	AK5 1000 CL1 Travaux	
PS0123	AK5 1000 CL2 Travaux	
PS0003	AK3 1000 CL1 Chaussée rétrécie	
PS0234	AK3 1000 CL2 Chaussée rétrécie	
PS0269	AK4 1000 CL1 Chaussée glissante	
PS0120	AK4 1000 CL2 Chaussée glissante	

Fournitures pour le BTP







Siège social : Lot. Farraux

Route de la Jaille -97122 BAIE MAHAULT

Tél : 0590.26.79.11 – Fax : 0590.26.82.66

LOCATION-VENTE







2. GAMME BK :

REFERENCE	DESIGNATION	
PS0038	BK0 850 CL1 Interdit à tous véhicule	
PS0058	BK0 850 CL2 Interdit à tous véhicule	
PS0040	BK1 850 CL1 Sens interdit	
FS0131	BK1 850 CL2 Sens interdit	
PS0008	BK14 30 850 CL1 Vitesse limité à 30Km/h	
PS0086	BK14 30 850 CL2 Vitesse limité à 30Km/h	
PS0006	BK14 50 850 CL1 Vitesse limité à 50Km/h	
PS0190	BK14 50 850 CL2 Vitesse limité à 50Km/h	
PS0097	BK14 70 850 CL1 Vitesse limité à 70Km/h	
PS0409	BK14 70 850 CL2 Vitesse limité à 70Km/h	
PS0095	BK14 90 850 CL2 Vitesse limité à 90Km/h	
PS0007	BK21 850 CL1 Obligation de tourner	
PS0216	BK21 850 CL2 Obligation de tourner	
PS0039	BK2a 850 CL1 Interdiction de tourner à gauche	
PS0045	BK2b 850 CL1 Interdiction de tourner à droite	
PS0005	BK3 850 CL1 Interdiction de dépasser	
PS0235	BK3 850 CL2 Interdiction de dépasser	
PS0035	BK31 850 CL1 Fin d'interdiction	
PS0215	BK31 850 CL2 Fin d'interdiction	
PS0020	BK6a1 850 CL2 Stationnement interdit	

LOCATION-VENTE

Fournitures pour le BTP
Siège social : Lot. Farraux
Route de la Jaille -97122 BAIE MAHAULT
Tél : 0590.26.79.11 – Fax : 0590.26.82.66

3. GAMME KD :

REFERENCE	DESIGNATION	
PS0032	KD22 1000X300 CL1 Déviation	
PS0118	KD22 1000X300 CL2 Déviation	
PS0057	KD22 1000X300 CL1 Piétons	
PS0403	KD22 1000X300 CL1 Piétons passez en face	
PS0009	KD22 1000X300 CL1 Piétons prenez le trottoir d'en face	
PS0404	KD22 1000X300 CL1 Piétons traversé obligatoire	
PS0011	BARRIERE K2 1400X200 CL1	
PS0162	BARRIERE K2 1400X200 CL2	
PS0010	BARRIERE K8 1500X500 CL1	
PS0202	BARRIERE K8 1500X500 CL2	
FS0006	PIQUET K5 SIMPLE FACE CL1	
FS0073	PIQUET K5 SIMPLE FACE CL2	

Fournitures pour le BTP













Siège social : Lot. Farraux

Route de la Jaille -97122 BAIE MAHAULT

Tél : 0590.26.79.11 – Fax : 0590.26.82.66

LOCATION-VENTE

4. GAMME KC1 :

REFERENCE	DESIGNATION	
PS0219	KC1 600X800 CL1 Absence de marquage	
PS0210	KC1 600X800 CL2 Absence de marquage	
PS0047	KC1 600X800 CL1 Attention travaux	
PS0081	KC1 600X800 CL1 Boue	
PS0206	KC1 600X800 CL1 Chantier interdit au public	
PS0414	KC1 600X800 CL1 Chantier mobile	
PS0014	KC1 600X800 CL1 Circulation alternée	
PS0171	KC1 600X800 CL2 Circulation alternée	
PS0088	KC1 600X800 CL1 Ralentir chantier	
PS0031	KC1 600X800 CL1 Route barrée	
PS0109	KC1 600X800 CL2 Route barrée	
PS0129	KC1 600X800 CL1 Route barrée avec disque	
PS0137	KC1 600X800 CL2 Route barrée avec disque	
PS0029	KC1 600X800 CL1 Sortie de camion	
PS0034	KC1 600X800 CL2 Sortie de camion	
PS0025	KC1 600X800 CL1 Sortie de chantier	
PS0074	KC1 600X800 CL2 Attention rainurage	
PS0413	KC1 600X800 CL2 Carrefour modifié	

LOCATION-VENTE

Fournitures pour le BTP

Siège social : Lot. Farraux

Route de la Jaille - 97122 BAIE MAHAULT

Tél : 0590.26.79.11 – Fax : 0590.26.82.66

5. PANNEAUX DE SIGNALISATION POLICE/ROUTIERE :

REFERENCE	DESIGNATION	
PS0050	AB4 600 CL1 Stop	
PS0177	AB4 600 CL2 Stop	
PS0051	B1 650 CL1 Sens interdit	
PS0275	B14 30 650 CL1 Vitesse limité à 30Km/h	
PS0159	B14 50 650 CL1 Vitesse limité à 50Km/h	
PS0128	B15 650 CL1 Circulation Alternée	
PS0122	A13b 700 CL1 Passage Piétons	
PS0160	A2b 700 CL1 Ralentisseur de type dos-d'âne	
PS0062	AB3a 1000 CL2 (AB3+M9C 500X200) Cédez le passage	
PS0112	B21 650 CL1 Obligation de tourner à droite	
PS0264	B6d 650 CL1 Arrêt et Stationnement interdit	
PS0250	M6h 150x500 CL1 Sauf Mobilité Réduite	
PS0268	C5 500 CL1 Taxis	
PS0241	C6 500 CL1 Arrêt d'autobus	
PS0021	C12 500 CL1 Circulation sens unique	
PS0127	C18 500 CL1 Priorité au sens inverse	
PS0256	C20A 500 CL1 Passage piétons	
PS0130	C27 500 CL1 Surélévation de chaussée	



LOCATION-VENTE

Fournitures pour le BTP
 Siège social : Lot. Farraux
 Route de la Jaille -97122 BAIE MAHAULT
 Tél : 0590.26.79.11 – Fax : 0590.26.82.66

PRE-FABRICATION ET LEVAGE

1. PREFABRICATION

REFERENCE	DESIGNATION	
CO0269	ANCRE A OEIL 2T5 LG 90MM	
CO0004	ANCRE A OEIL 5T 90MM	
CO0242	ANCRE A OEIL 5T 120MM	
CO0322	ANCRE A OEIL 10T 180MM	
CO0241	ANCRE A PIED 1T3 LG 120MM	
CO0240	ANCRE A PIED 1T3 LG 170MM	
CO0106	ANCRE A PIED 2T5 LG 120MM	
CO0239	ANCRE A PIED 2T5 LG 170MM	
CO0232	RESERVATION ELASTO COMPLETE 1T3	
CO0237	RESERVATION ELASTOMERE COMPLETE 2T5	
CO0255	RESERVATION ELASTOMERE COMPLETE 5T	



LOCATION-VENTE

Fournitures pour le BTP
 Siège social : Lot. Farraux
 Route de la Jaille -97122 BAIE MAHAULT
 Tél : 0590.26.79.11 – Fax : 0590.26.82.66

2. LEVAGE

REFERENCE	DESIGNATION	
CO0234	ANNEAU DE LEVAGE 1T3	
CO0221	ANNEAU DE LEVAGE 2T5	
CO0254	ANNEAU DE LEVAGE 5T	
CO0187	CROCHET DE MANUTENTION TREILLIS SOUDES	
CO0012	ELINGUE 4 BRIN EN METAL- 1T-1ML	
CO0230	ELINGUE TUBULAIRE 1T-2ML VIOLETTE	
CO0271	ELINGUE TUBULAIRE 2T-3ML VERTE	
CO0229	ELINGUE TUBULAIRE 3T-2ML JAUNE	
CO0218	ELINGUE TUBULAIRE 3T-4ML JAUNE	